

**SAW Filter 490.0MHz**  
**Part No: MP04074**

**Model: TA1112A**  
**Rev No:1**

**A. MAXIMUM RATING:**

1. Input Power Level: 10dBm
2. DC Voltage: 5V
3. Operating Temperature: -30°C to +60°C
4. Storage Temperature: -40°C to +85°C

**B. ELECTRICAL CHARACTERISTICS:**

| Item                                   | Unit   | Min. | Typ. | Max. |
|--|--------|------|------|------|
| Center frequency Fc                    | MHz    | -    | 490  | -    |
| Insertion loss (480 ~ 500MHz) IL       | dB     | -    | 2.4  | 3.2  |
| Amplitude Ripple (480 ~ 500MHz)        | dB     | -    | 0.9  | 2.4  |
| Return loss (480 ~ 500MHz)             | dB     | 6    | 7.3  | -    |
| Attenuation (Reference level from 0dB) |        |      |      |      |
| 0.3 ~ 300MHz                           | dB     | 30   | 58   | -    |
| 300 ~ 380MHz                           | dB     | 24   | 55   | -    |
| 380 ~ 460MHz                           | dB     | 15   | 50   | -    |
| 534.825 ~ 554.825MHz                   | dB     | 12   | 53   | -    |
| 559.65 ~ 579.65MHz                     | dB     | 28   | 55   | -    |
| 669.3 ~ 689.3MHz                       | dB     | 24   | 49   | -    |
| 689.3 ~ 1000MHz                        | dB     | 26   | 43   | -    |
| Temperature Coefficient of Frequency   | ppm/°C | -    | -36  | -    |

**C. MEASUREMENT CIRCUIT:**

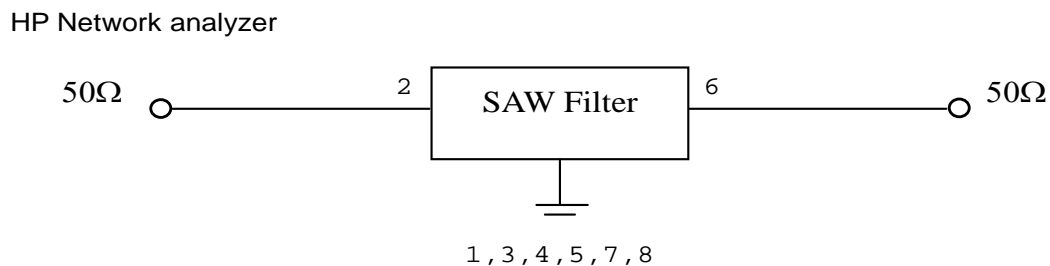

**SAW Filter 490.0MHz**  
**Part No: MP04074**

**Model: TA1112A**  
**Rev No:1**

**D. OUTLINE DRAWING:**

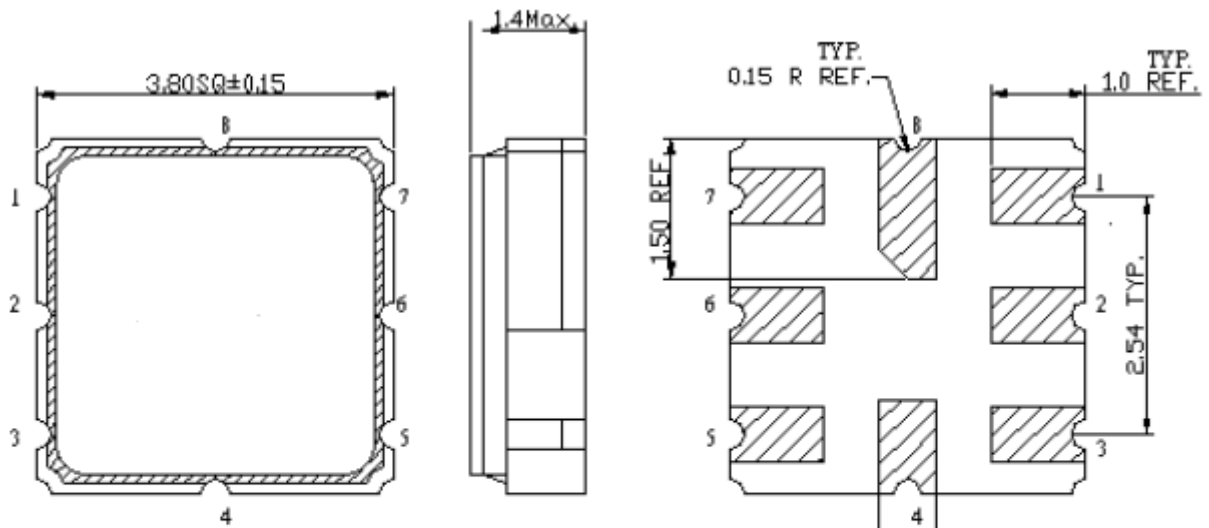

2 : Input  
6: Output  
1,3,4,5,7,8: Ground

**E. PCB FOOTPRINT:**

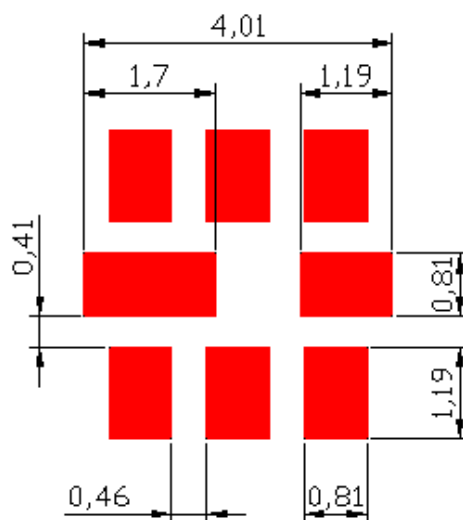

**SAW Filter 490.0MHz**  
**Part No: MP04074**

**Model: TA1112A**  
**Rev No:1**

**F. FREQUENCY CHARACTERISTICS:**

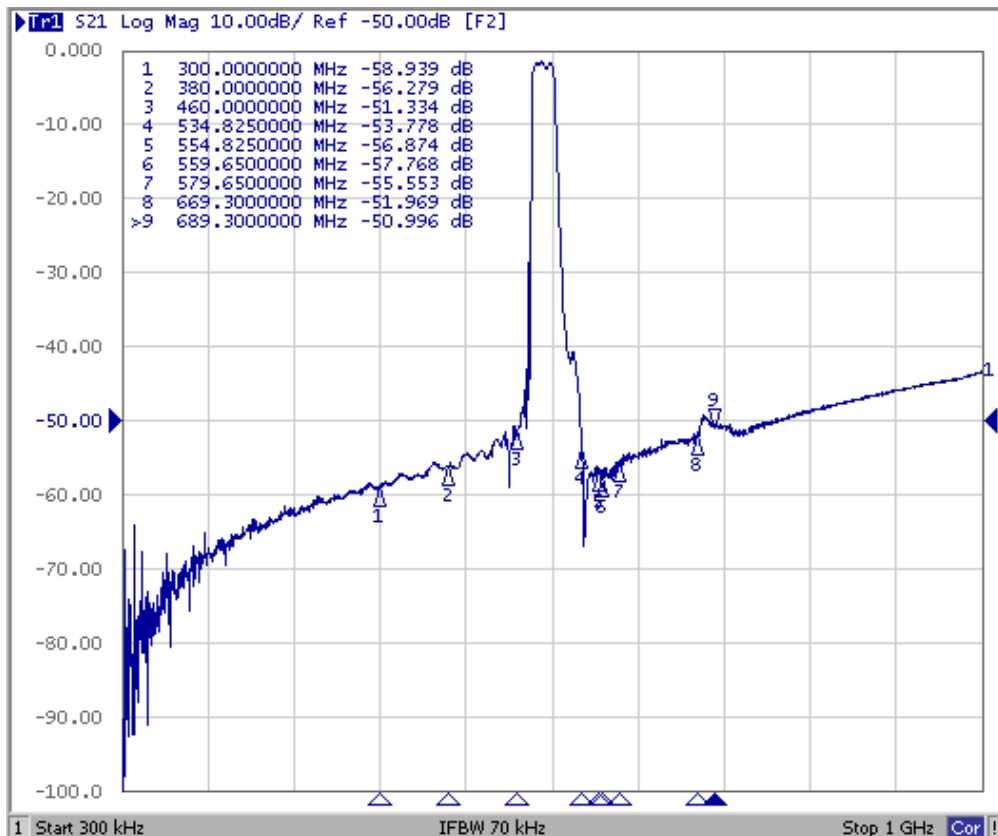
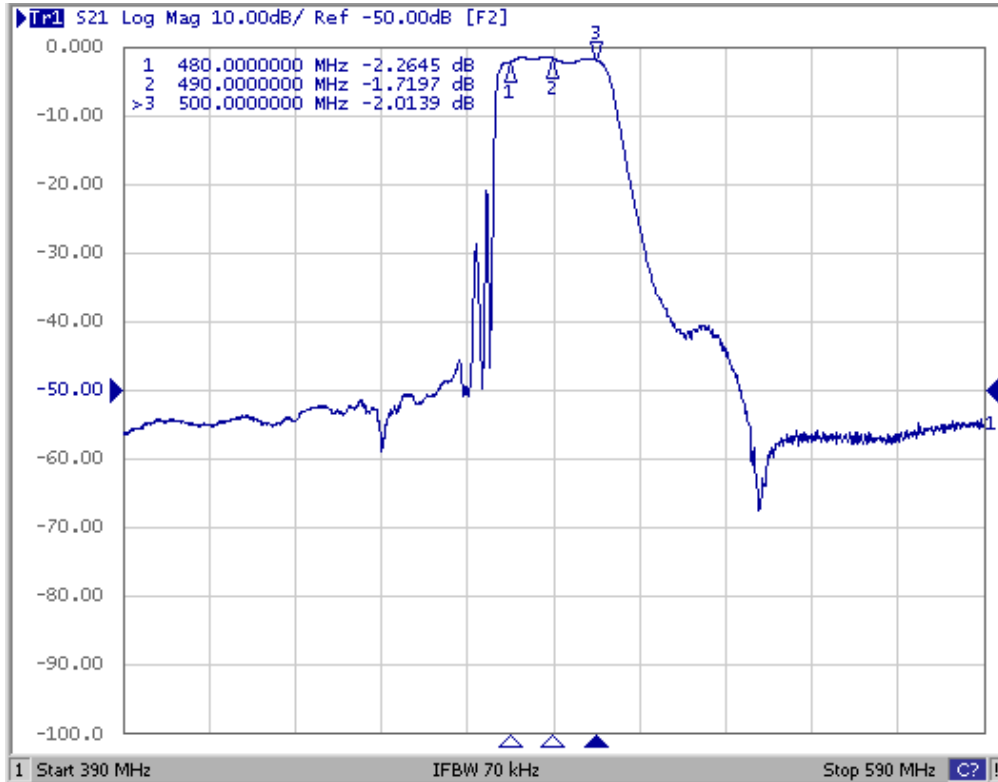

**SAW Filter 490.0MHz**  
**Part No: MP04074**

**Model: TA1112A**  
**Rev No:1**

**G. PACKING:**

1. Reel Dimension

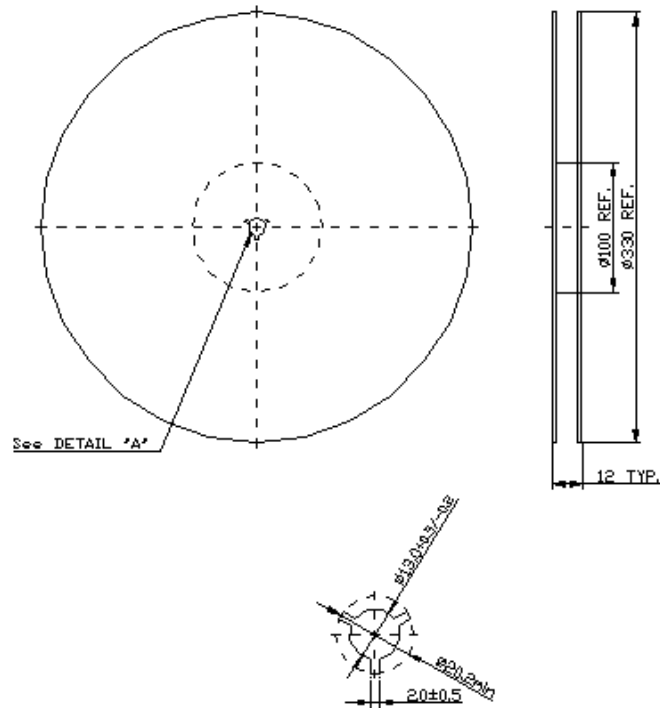

2. Tape Dimension

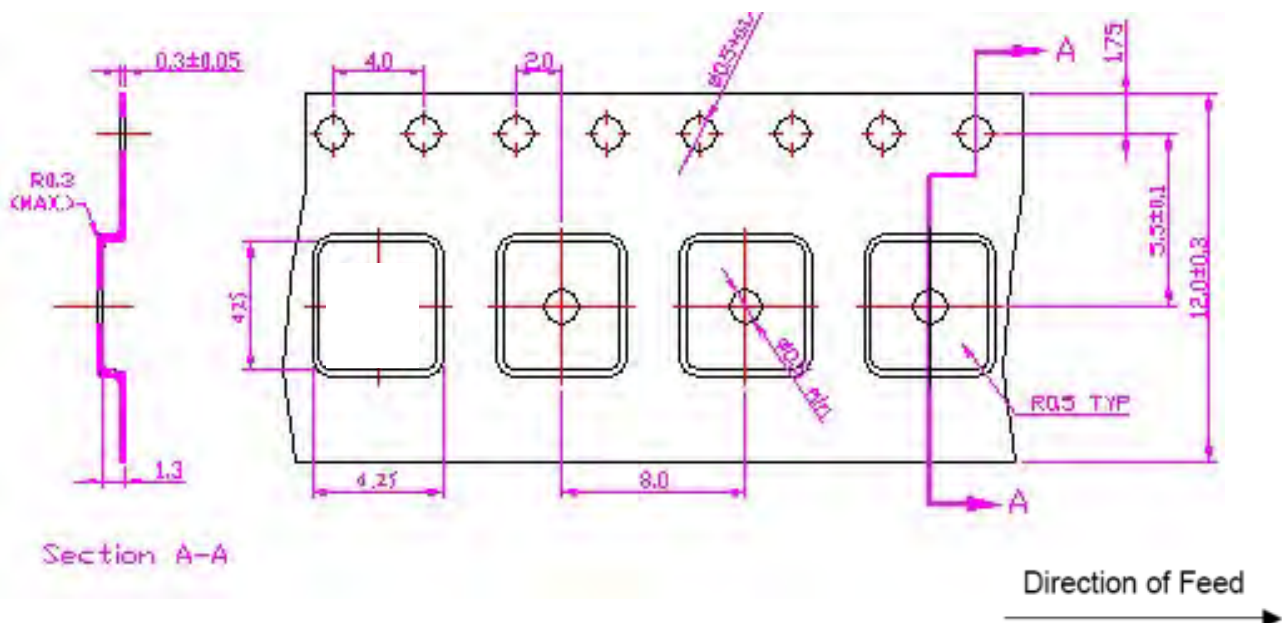

**SAW Filter 490.0MHz**  
**Part No: MP04074**

**Model: TA1112A**  
**Rev No:1**

**H. RECOMMENDED REFLOW PROFILE:**

